

DANCOVER[®]

.com

Manual
Party tent
CombiTents
6m Series PVC

DANCOVER[®]

.com

Safety Advice

Attention

In some countries approval is needed to set up a marquee/tent larger than 75 m². It is your responsibility to comply with local rules and regulations and to ensure that the marquee/tent is assembled correctly.

In case of bad weather conditions, it is your responsibility to ensure the marquee/tent is safely secured and that the marquee/tent does not cause damage to others.

Do not use open fire, welding equipment or other sources which can ignite, inside or close to the tent.

The marquee/tent must be safely secured. We recommend you secure your marquee/tent with straps and pegs as soon as it is assembled.

Make sure to check if the marquee/tent is covered by your home contents insurance.

Marquees/tents must be evacuated under extreme weather conditions.

In the event of snow always remove snow from the roof of the marquee/tent regularly to prevent snow from building on the roof as heavy snow can cause the marquee/tent to collapse.

In the event of rain there is a risk of rain puddles building up on top of the roof of the marquee/tent. Heavy rain puddles can cause the roof to collapse. It is your responsibility to ensure rain puddles do not build up. As a precaution, make sure the roof of the marquee/tent is stretched out properly and adequately over the side frames of the marquee/tent and remove rain water regularly.

Do not unpack or repack your marquee/tent in freezing temperatures. In case of temperatures below zero always unpack and repack your marquee/tent indoors to avoid the risk of cracking parts.

The marquee/tent must be totally dry before you repack and store it to avoid mildew.

Note: Marquees are intended for events and other arrangements and are as such only meant for short term temporary assembly and the following disassembly. Dancover warranty applies only to the normal use of the Product, normal wear and tear excepted, in accordance with written use instructions or manual. The warranty does not apply to damage caused by accident, abuse, misuse, or modification of the Product.

Warranty Information

Please visit dancovershop.com for information on warranty.

Please always check our website for the latest safety advice and manual.

Warning

1
The pipes are covered in oil. Before you set up your tent please remove the oil carefully to keep the cover clean.





2
Take note that the tent needs to be handle with care to avoid damages.

3
Do not force the frame as they may be damage in the process.



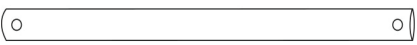



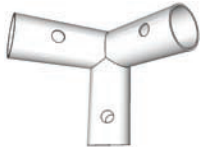
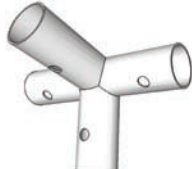
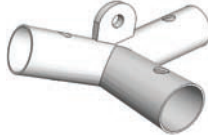
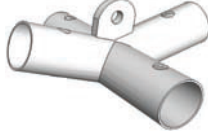
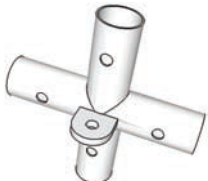
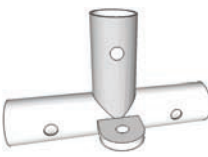
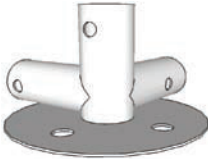
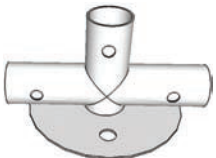
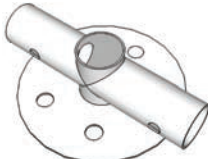



4
Tents are meant as temporary shelters and must be evacuated under extreme weather conditions.

Please select a suitable site for the tent to avoid damage to underground sprinkler systems, water, gas or electrical lines.

Part list for 6m PVC Party Tent, CombiTents

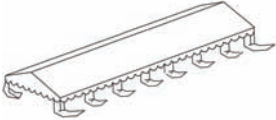
Part No.		6m	8m	10m	12m	14m
1	 1470mm	16	20	24	28	32
2	 1940mm	27	34	41	48	55
3	 1880mm	8	10	12	14	16
4	 1495mm	8	10	12	14	16
5	 550mm	4	5	6	7	8
6	 110°	4	4	4	4	4
7	 110°	4	6	8	10	12
8	 140°	2	2	2	2	2
9	 140°	2	3	4	5	6
10	 4	4	6	8	10	12
11	 4	4	4	4	4	4
12	 4	4	4	4	4	4
13	 4	4	6	8	10	12
14	 4	4	4	4	4	4

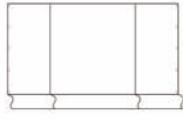
Part list for 6m PVC Party Tent, CombiTents

Part No.		6m	8m	10m	12m	14m
15		4	4	4	4	4
16		8	10	12	14	16
17		36	42	48	54	60
18		102	128	154	180	206
19		16	20	24	28	32
20		112	132	152	172	192
22		4	4	4	4	4
24		1 (2 sections)	1 (3 sections)	1 (3 sections)	1 (4 sections)	1 (5 sections)
25		6	8	10	12	14
26		1	1	1	1	1
27		1	1	1	1	1
28		16	20	24	28	32

6m PVC Party Tent, CombiTents

CombiTent roof explained

6x6

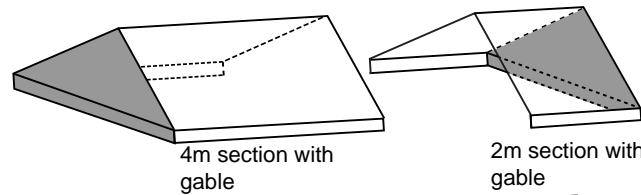

6x8

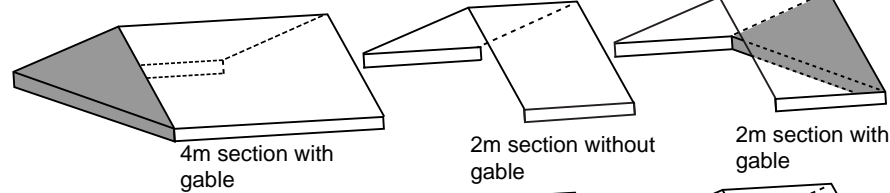

6x10

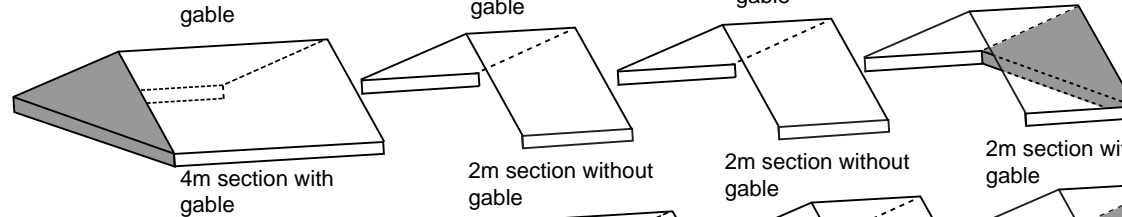

6x12

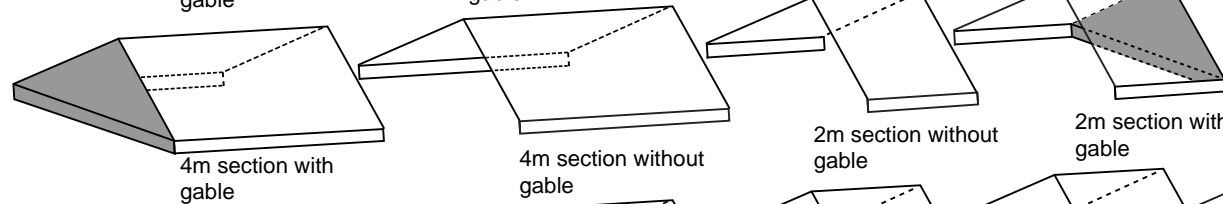

6x14

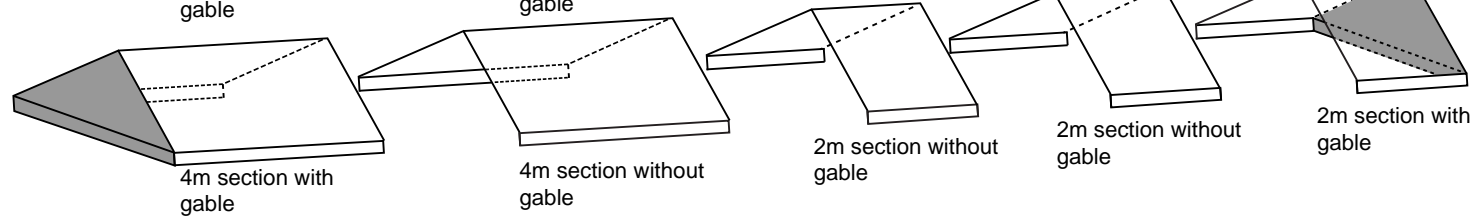

When you are making your CombiTent **shorter**. Use the velcro overlay to detach roof sections.

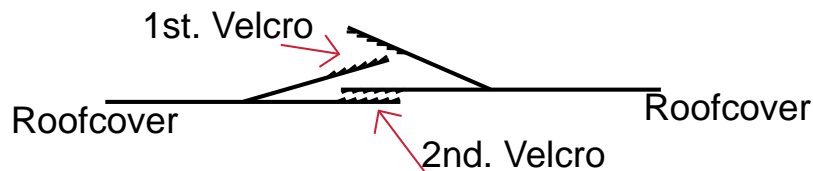

Use the velcro overlay to attach 2 roof sections to each other.

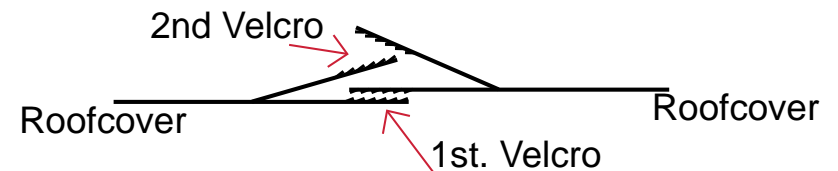

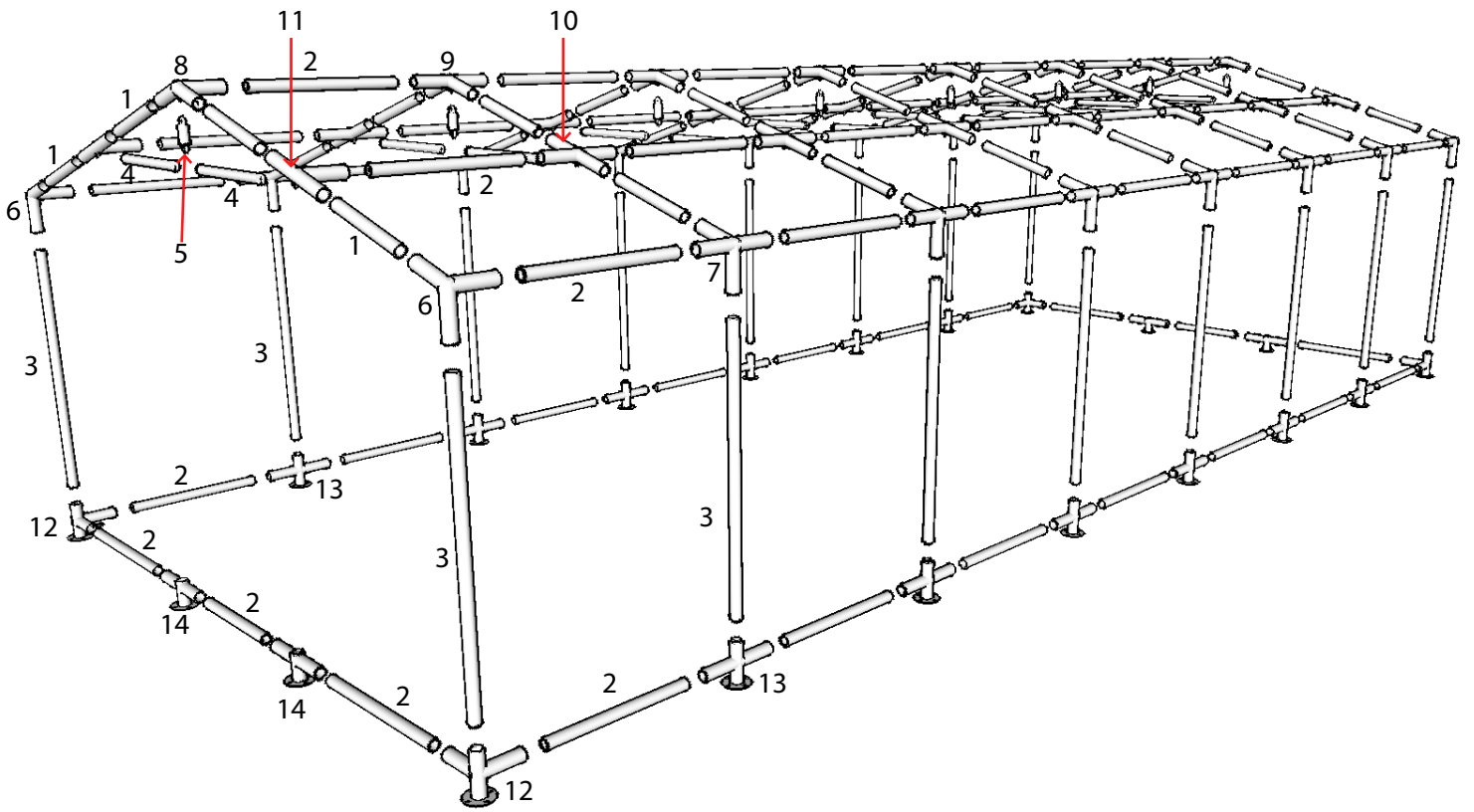

A

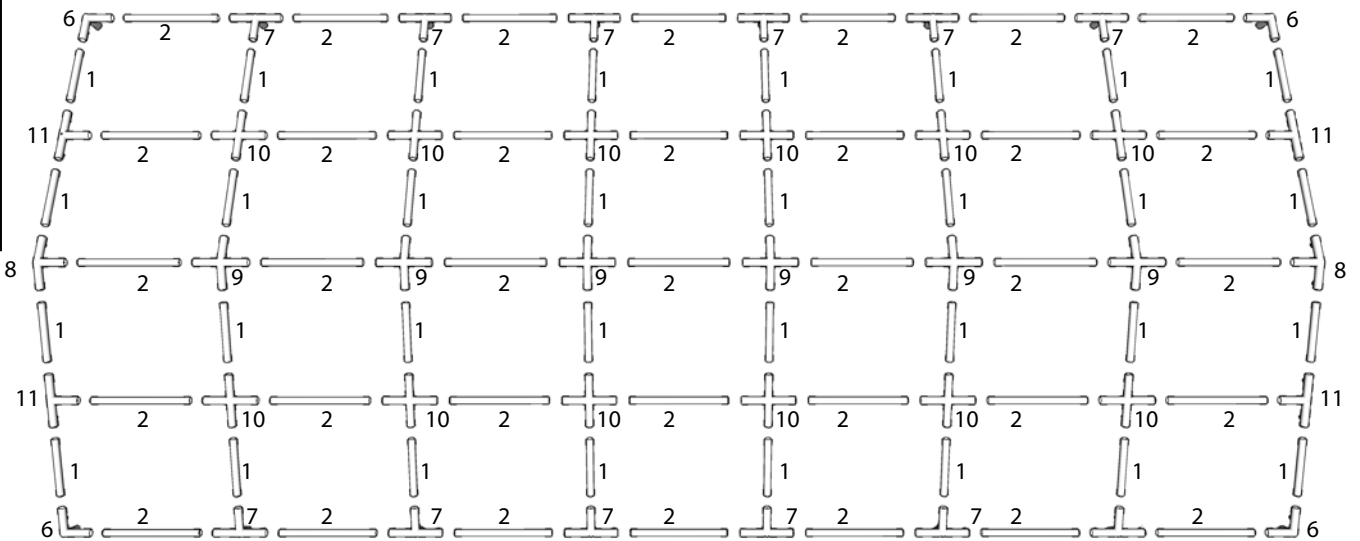

B

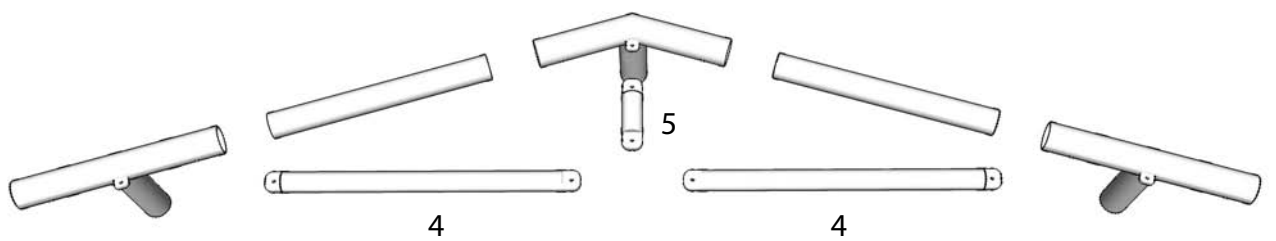

DANCOVER®

C

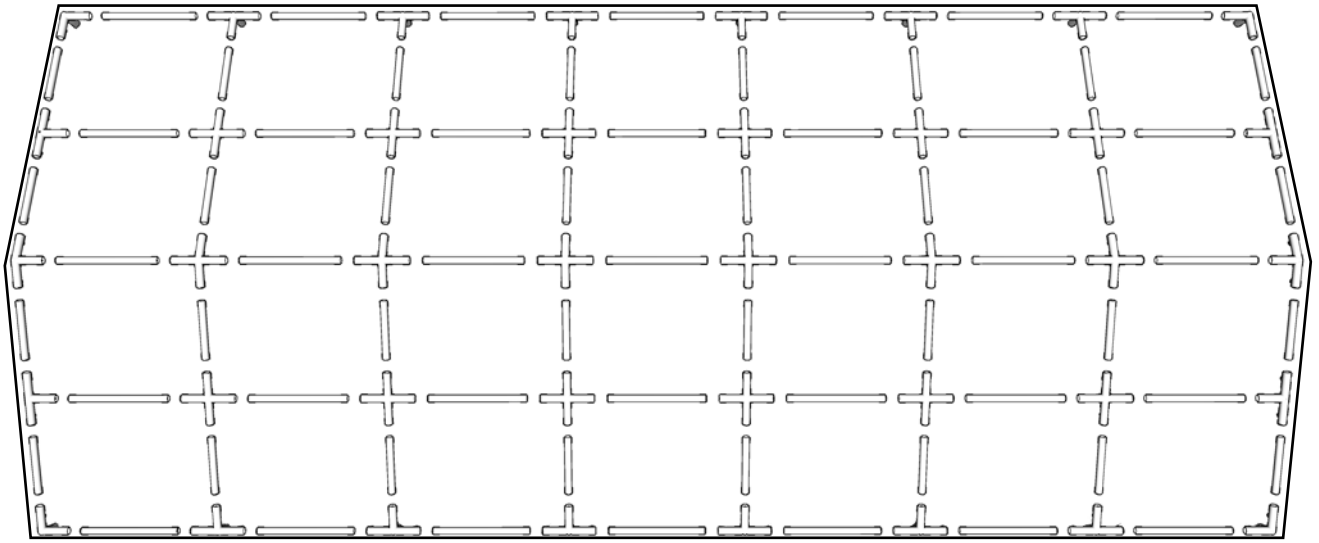
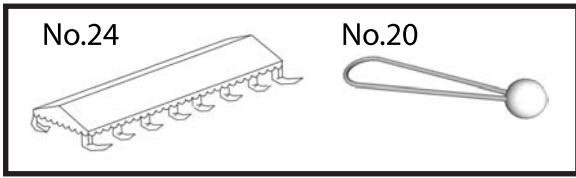

D

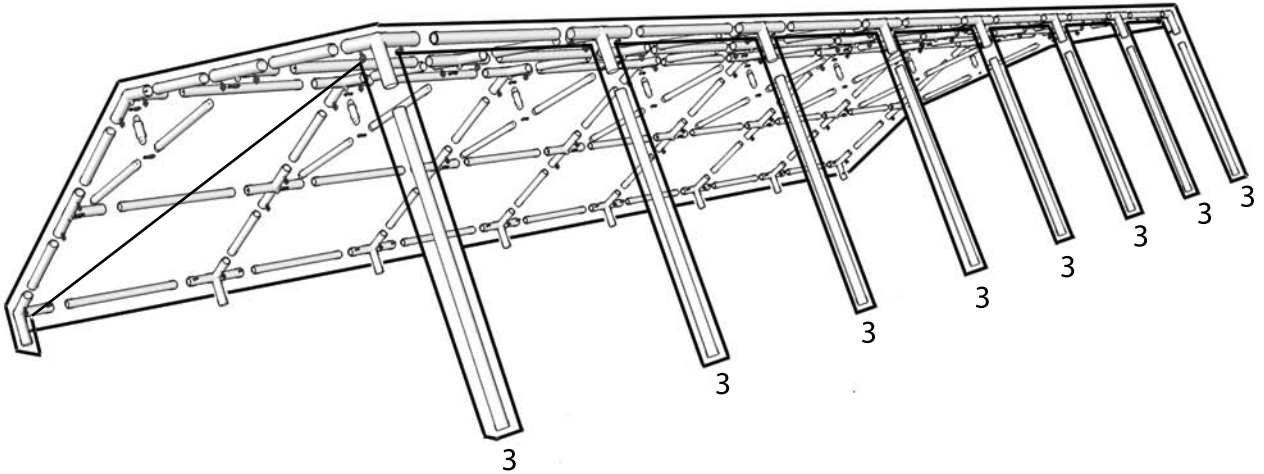

E

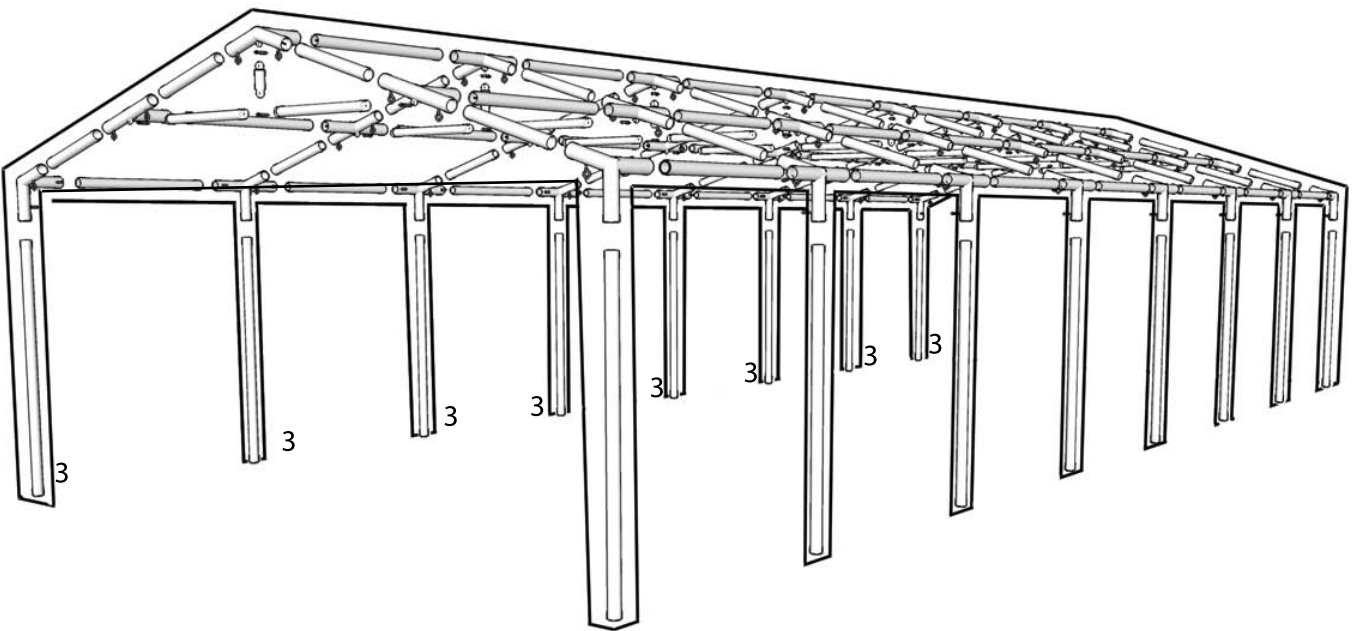

F

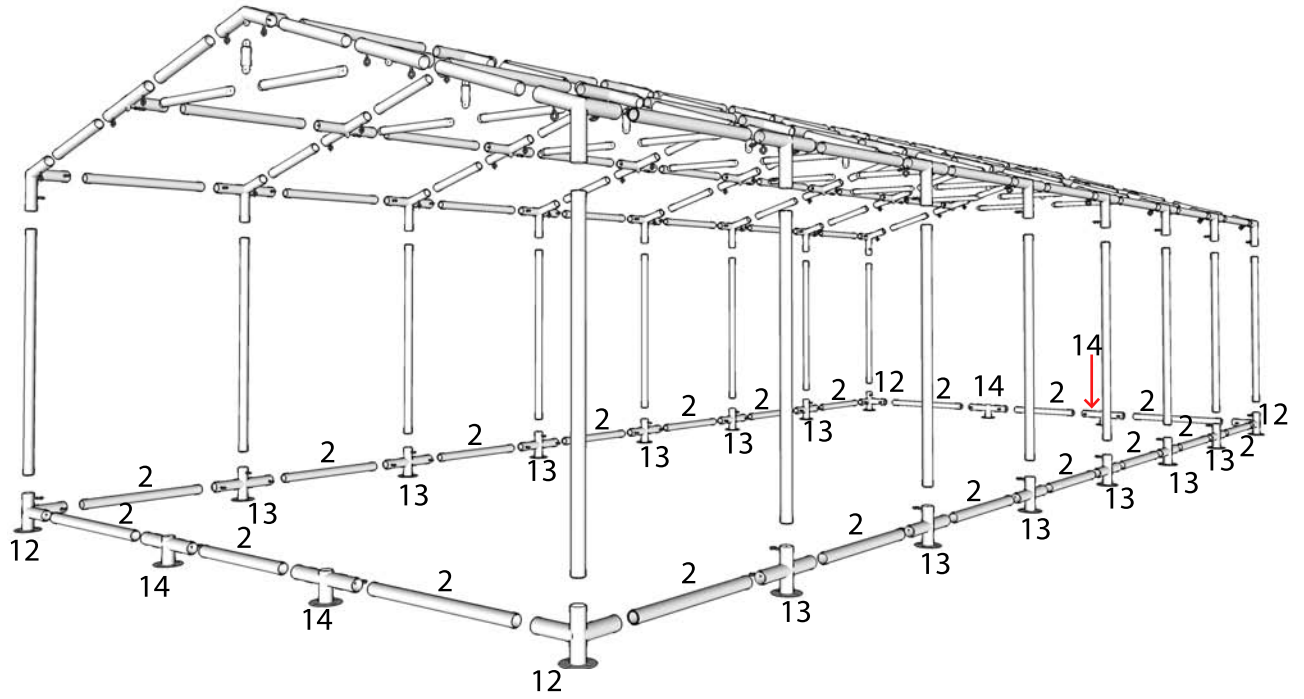
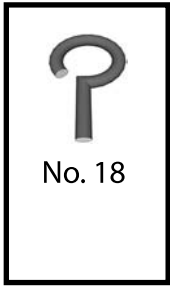

G

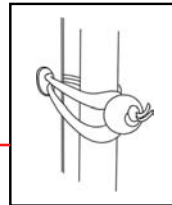
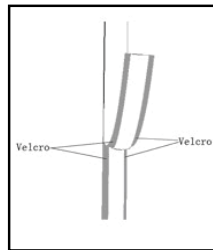
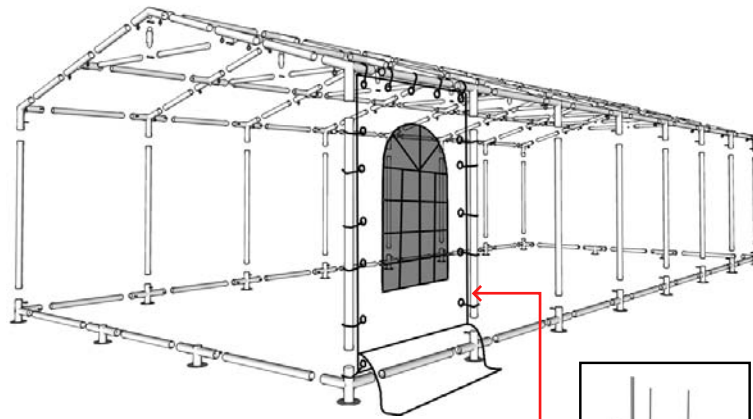
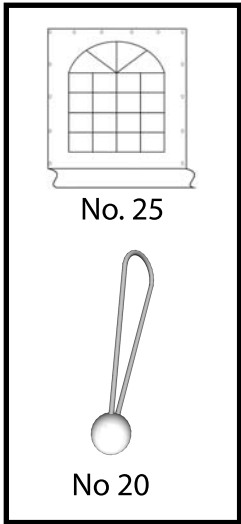

H

